



Paulmann

SafetyInstructions

1, 2, 3, 4, 5, 6, 7, 10, 9, 19, 21, 24, 25, 26, 27, 28, 29, 30, 32, 34



Info

www.paulmann.com

Paulmann Licht GmbH
Quezinger Feld 2
31832 Springe
Germany

www.paulmann.com

Art.-Nr.:
500.18A

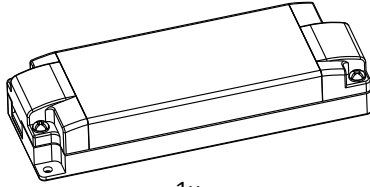

1x

(+MA 0326)PKE 07/17



Bluetooth Master Switch/Dimm

INPUT: 220-240V~50Hz max.2.5A

OUTPUT:220-240V~50Hz

max.300W (Resistive Load)

max.100W (Capacitive Load)



A

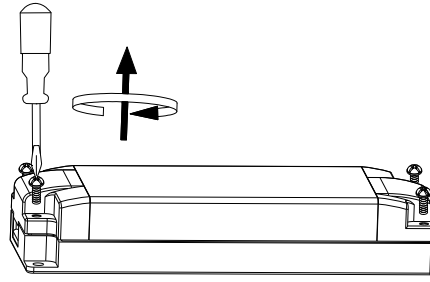

Safety Instructions

Nr. 1, 2, 4



B

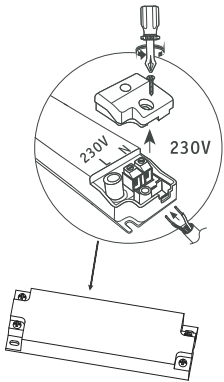

INPUT:
OUTPUT:

1.

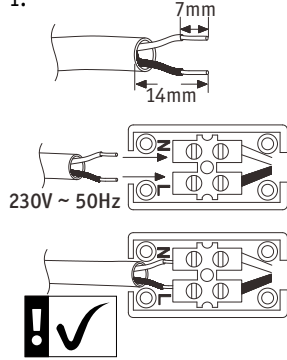

2.

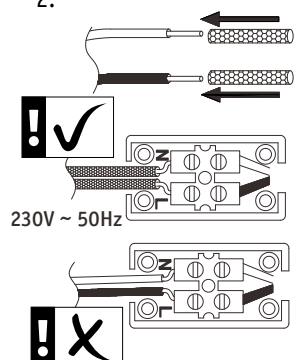

Safety Instructions

Nr. 4, 5, 6

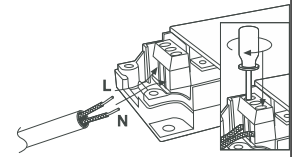

C

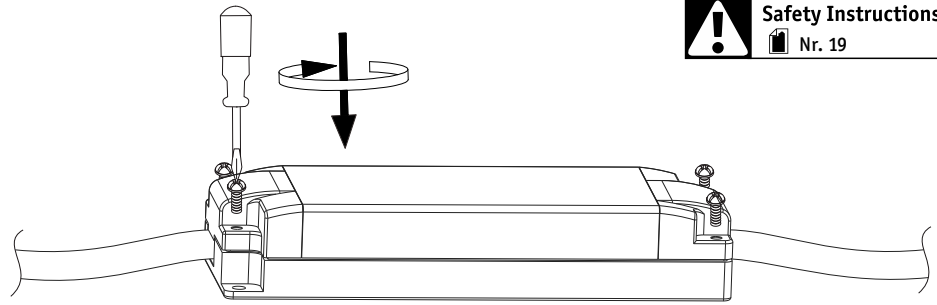

Safety Instructions

Nr. 19



D

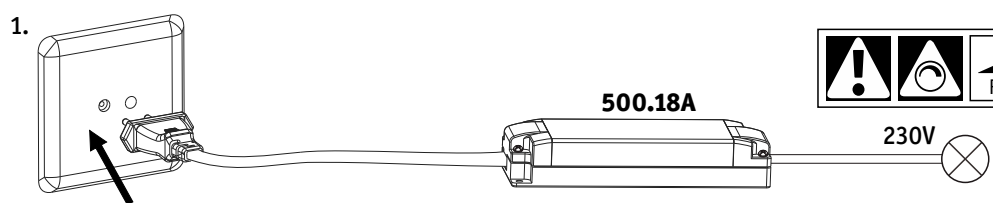

Safety Instructions

Nr. 19, 30, 32

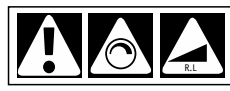
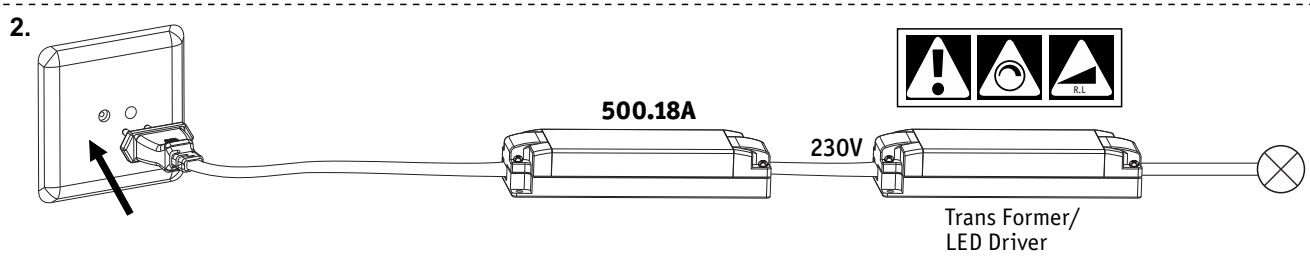

Trans Former/
LED Driver

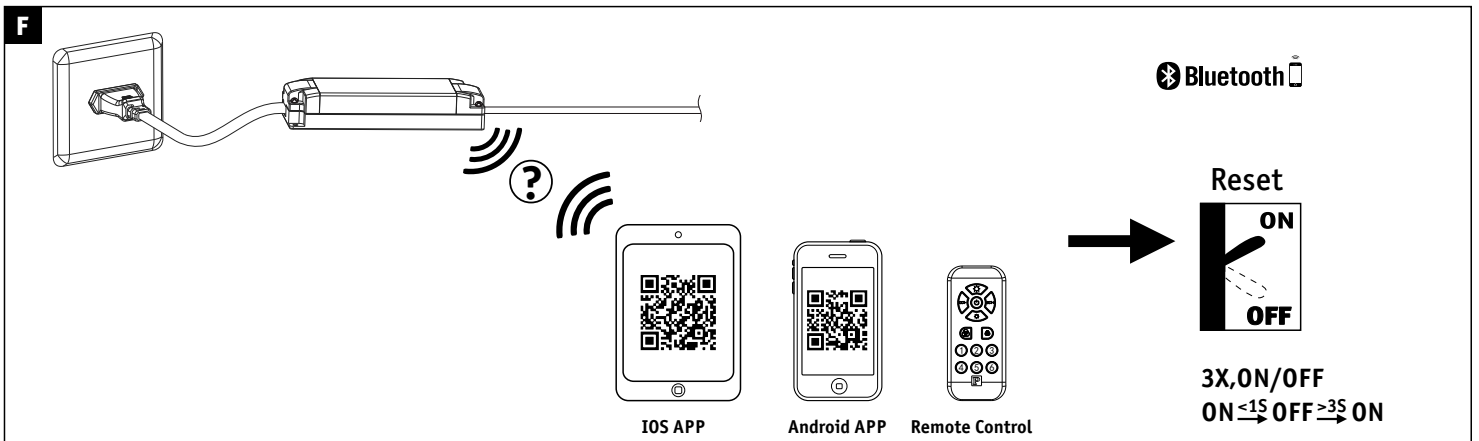
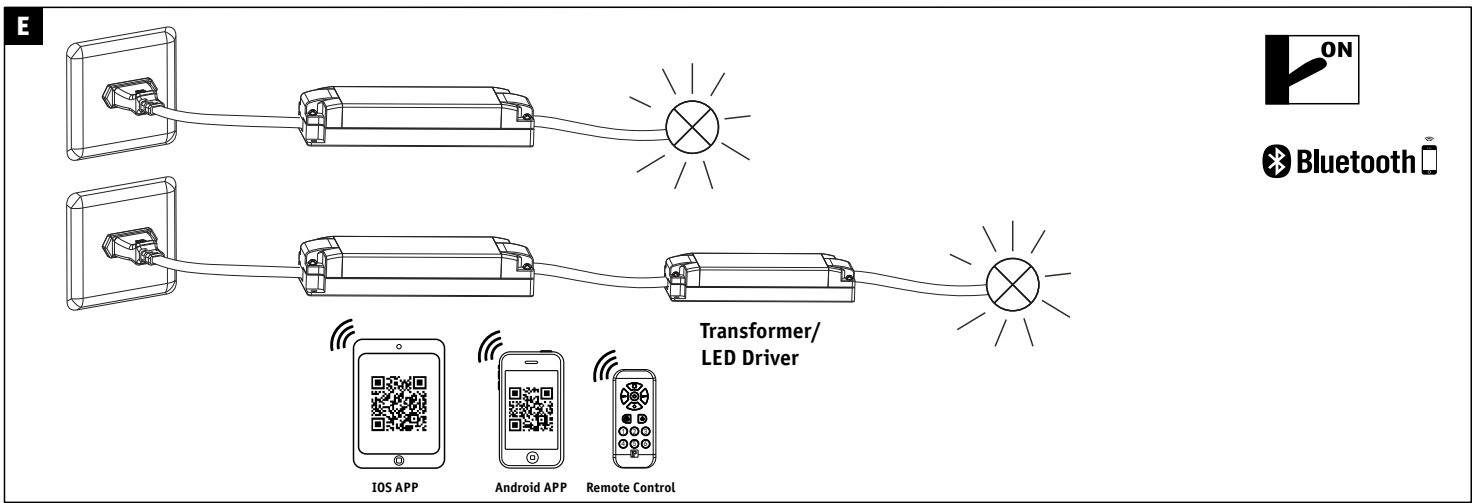

G

Paulmann Home

iOS APP

Android APP

Not incl.

- iPad
- iPhone 4S Higher
- Android 4.4 Higher
- Bluetooth 4.0 Higher

Not incl. Remote Control

Paulmann
Art.-Nr.500.01

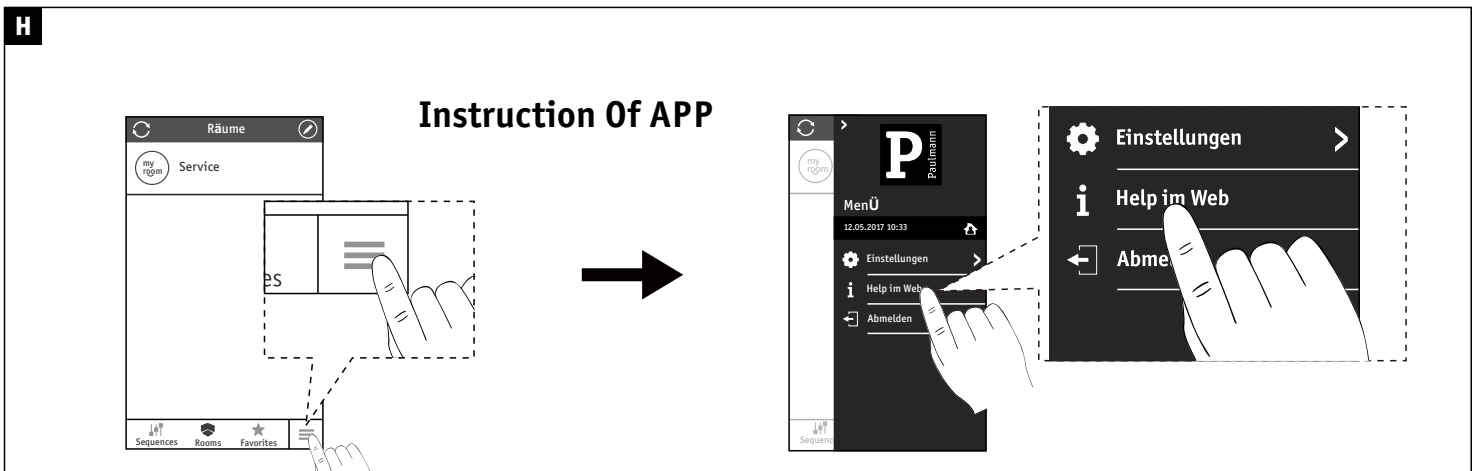

Hiermit erklärt Paulmann Licht, dass der Funkanlagentyp Art.-Nr: 500.18A Richtlinie 2014/53/EU entspricht. Der vollständige Text der EU-Konformitätserklärung ist unter der folgenden Internetadresse verfügbar: www.paulmann.de