

# SIRI 44-L

A28442.xx

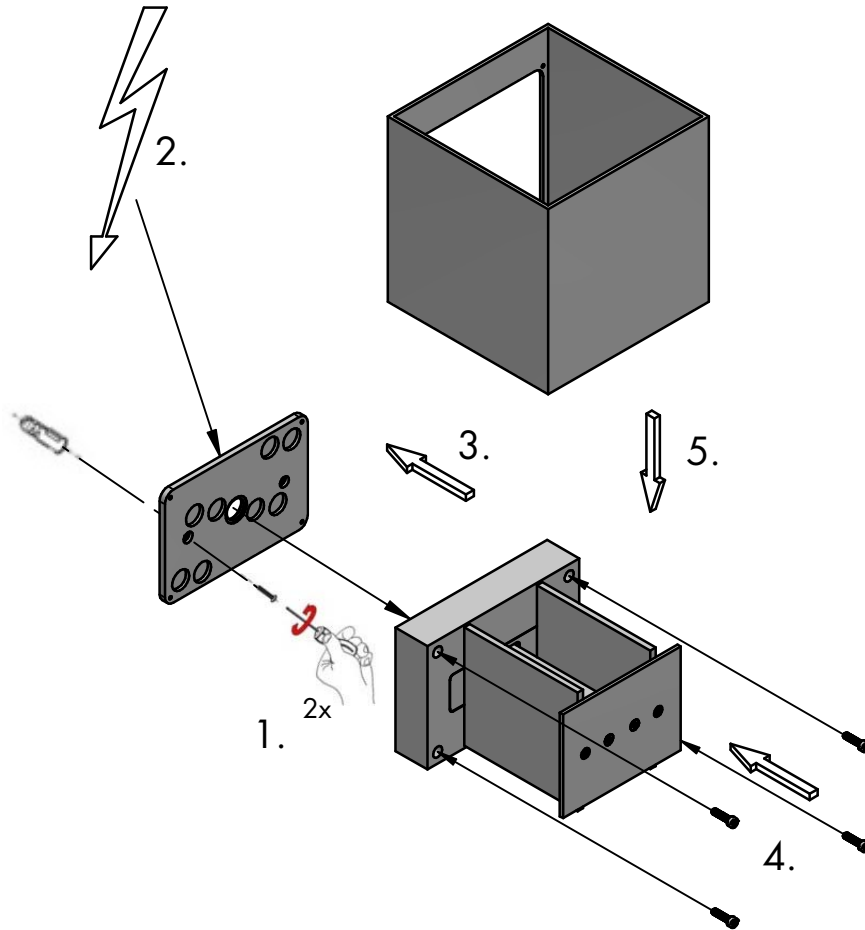

Bitte beachten Sie unsere allgemeinen Hinweise !  
Please observe our general information !  
Nous vous prions d'observer nos instructions g n rales !  
Observen por favor nuestra informaci n general !

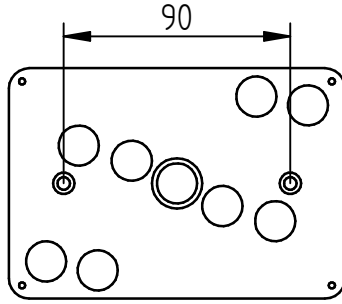
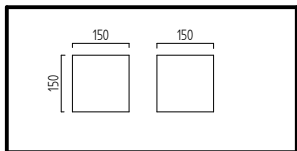
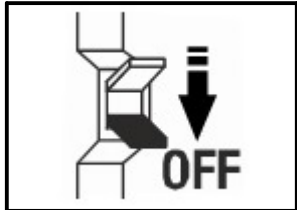
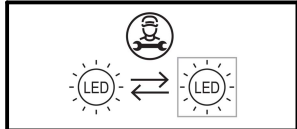
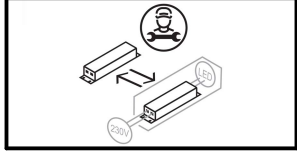
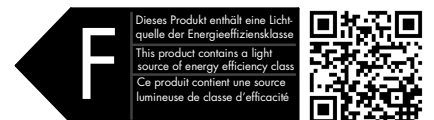

[www.helestra.de/installation](http://www.helestra.de/installation)

**Helestra Leuchten GmbH**

An den Breiten 7, 01454 Leppersdorf, Deutschland/Germany

[www.helestra.de](http://www.helestra.de)